

## Contents

<b>Introduction</b> .....	<b>1</b>
<b>Checking Upon Receiving</b> .....	<b>3</b>
Accessories .....	5
<b>Safety Instructions</b> .....	<b>6</b>
Safety Symbol Descriptions .....	6
Points of Attention During Operation .....	8
<b>General Description</b> .....	<b>12</b>
Product Introduction .....	12
Names and Functions Of Components .....	13
<b>Preparations Before the Test</b> .....	<b>21</b>
Power Check .....	21
Auto powering off.....	25
Setting and Checking Date / Time .....	26
Connecting Testing Wires .....	26
<b>Test Method</b> .....	<b>28</b>
Checking before the Test.....	28
Measuring with 3-pole/4-pole method .....	28
Test of Earthing-Resistance without Stake.....	35
AC Resistance Test .....	37
DC Resistance Test .....	38
Soil Resistivity Test.....	40
Test-wire resistance (Rk) measurement .....	42
Interference voltage/frequency test.....	43
Interference-Current Test .....	44
<b>For Saving Test Data</b> .....	<b>46</b>
Data Storage.....	46
Reviewing Saved Data.....	47
Deleting Saved Data.....	49
<b>PC Communication</b> .....	<b>50</b>



Operation System Requirement: .....	50
Functions of PC Software .....	50
Installing PC Software: .....	50
Downloading Data to PC/Configuring the Tester .....	50
<b>Specifications .....</b>	<b>51</b>
General Specifications .....	51
Technical Specification .....	53
<b>Maintenance and Repair .....</b>	<b>60</b>
Table of trouble shooting .....	61
Cleaning .....	62
Disposal .....	62
<b>Appendix table: Soil resistivity .....</b>	<b>63</b>

## Introduction

Thanks for purchasing the advanced earthing resistance tester designed and manufactured by our company. In order to ensure the proper use of the tester, please read this manual carefully before operating and keep it at a place where it can be easily found.

With the latest technology in a small-sized, robust and easy-to-use instrument, this series of earthing resistance tester is mainly used to test the earthing resistance of transformer, lightning-proof system, high-voltage power tower and telecommunication equipments, etc., providing a perfect solution for earthing-resistance test.

There are three models of this series, including Meter A, Meter B and Meter C, which can meet various requirements of different customers. The features are summarized in the following table.

Test mode	Functions	MS2308	MS2307	MS2306
3 pole & 4 pole earthing-resistance test	Test voltage: AC 20V/48V	√	√	√
	Test frequency: 94Hz/105Hz/111Hz/128Hz/AFC	√	√	94Hz/128Hz
	Earthing-resistance range	0.02Ω ~ 300kΩ	0.1Ω ~ 30kΩ	0.1Ω~20kΩ
Selective mode (3 pole +  / 4 pole +  )	Test voltage: AC 20V/48V	√	√	
	Test frequency: 94Hz/105Hz/111Hz/128Hz/AFC	√	√	
	Earthing-resistance range	0.02Ω~20kΩ	0.1Ω~10kΩ	
Non-auxiliary-polar mode (  )	Test voltage: AC48V	√	√	
	Test frequency: 94Hz/105Hz/111Hz/128Hz/AFC	√	√	
	Earthing-resistance range	0.02Ω~150Ω	0.1Ω~150Ω	

Test mode	Functions	MS2308	MS2307	MS2306
2 pole R~	Test voltage: AC20V	√	√	√
	Test frequency: 94Hz/105Hz/111Hz/128Hz/AFC	√	√	94Hz/128Hz
	Earthing-resistance range	0.02Ω ~ 300kΩ	0.1Ω ~ 30kΩ	0.1Ω~20kΩ
2 pole /4pole R 	Test voltage: DC20V	√	√	
	Earthing-resistance range	0.02Ω ~ 3kΩ	0.1Ω ~ 3kΩ	
Interfering voltage /current/frequency	Interfering voltage: 1~50V DC/AC	√	√	√
	Interfering frequency: 16Hz~400Hz	√	√	√
	Interfering current: 20mA~2A	√	√	
Soil resistivity ρ	Test voltage: AC20V/48V	√	√	√
	Test frequency: 94Hz/105Hz/111Hz/128Hz/AFC	√	√	94Hz/128Hz
	Range: 0.02Ω • m~1000kΩ • m	√	√	√
RK(wire compensation)	Test voltage: AC20V/48V	√	√	√
	Test frequency: 94Hz/105Hz/111Hz/128Hz/AFC	√	√	94Hz/128Hz
	Range:	0.02~30Ω	0.1~30Ω	0.1~30Ω
	Test current	≤ 250 mA	≤ 100 mA	≤ 100 mA
	Data storage	√	√	√
	USB communication	√	√	√

## Checking Upon Receiving

Upon receiving, please firstly carefully check the tester. Please contact your supplier in case there is any obvious damage or any malfunction during the transaction.

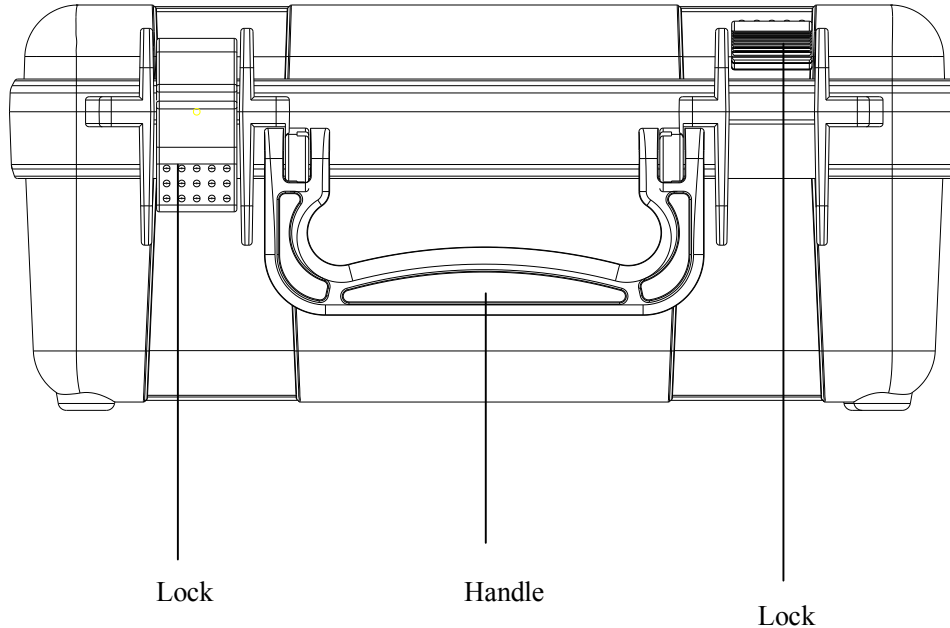
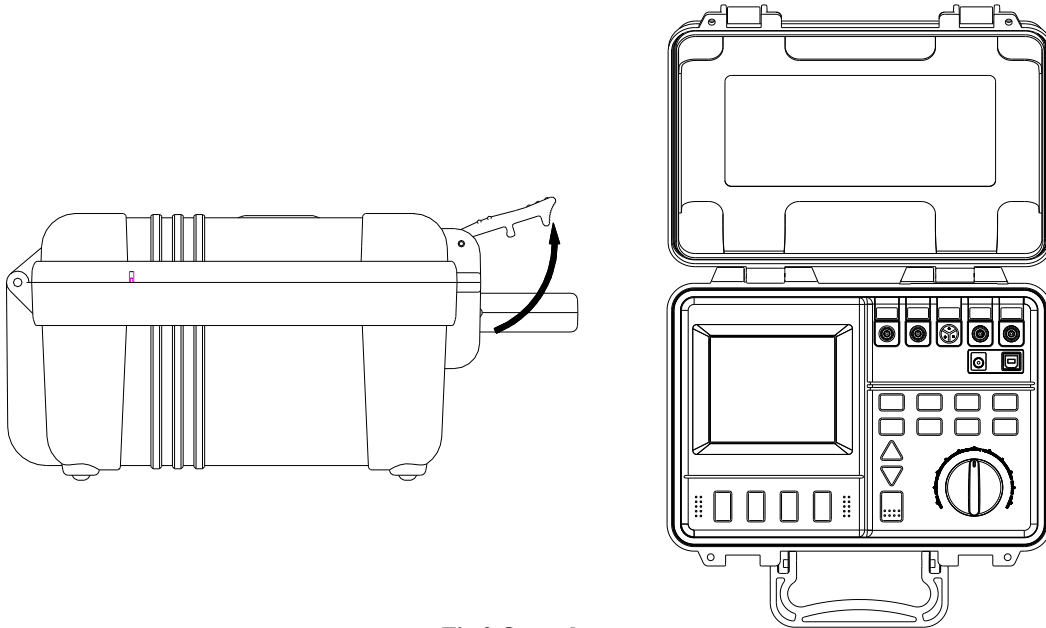

**Fig. 1 Appearance**

---







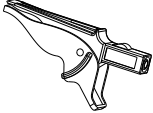

**To open the case:**

1. Use your fingers to pull lock buckle outward.
2. Lift lock buckle upward so as to release two buckles, and open the outer case.

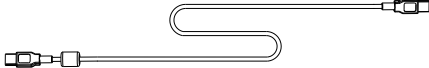

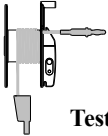
**Fig.2 Open the case**

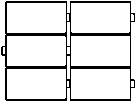
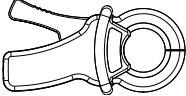
**Accessories**

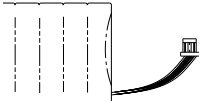
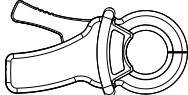
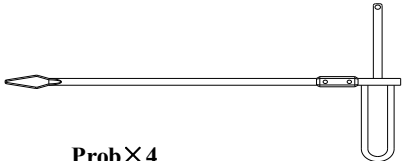
 <p><b>Clip ×4</b></p>	 <p><b>Charger(optional)</b></p>	 <p><b>USB cable</b></p>
 <p><b>User manual</b></p>	 <p><b>Test wire×4</b></p>	 <p><b>Voltage clamp cable</b></p>
 <p><b>Alkaline battery ×6</b></p>	 <p><b>Voltage Transformer φ 51mm</b></p>	 <p><b>Current clamp cable</b></p>
 <p><b>Rechargeable Ni-MH battery (Optional)</b></p>	 <p><b>Voltage Transformer φ 51mm</b></p>	 <p><b>Prob×4</b> <span style="float: right;"><b>Prob</b></span></p>

## Safety Instructions







### Danger

The design of this instrument meets IEC61010 requirement, and tests in all aspects have been performed before packaging and shipment. Nevertheless, improper handling during operating may still cause damages to the tester and accidents in which physical injury or even death might occur. Please read this manual carefully before usage. Our company is not liable for any physical injury or accident that is caused by reasons other than flaws of the testing instrument itself.





### Safety Symbol Descriptions

#### Safety Instructions



	Important information which the user shall read before use.
	Indication of possible dangerous voltage on the terminal.
	Indicating that this is an equipment with enhanced insulation.
	DC Signal
	AC Signal



**Warning Information**

 <b>Danger</b>	Indicating that improper operation will cause accidents in which extremely serious injury or even death might occur
 <b>Warning</b>	Indicating that improper operation will cause accidents in which serious injury or even death might occur
 <b>Note</b>	Indicating that improper operations will cause physical injury to the operator, or damage to the tester.
 <b>Tips</b>	Operation suggestions or tips

**Descriptions for other symbols**

	Prohibited operation
	Quick reference

**Definition of the Precision Symbols**

<b>dgt. (resolution)</b>	The smallest unit of displaying for digital tester.
<b>rdg. (reading or displayed value)</b>	Current reading of tester

---

## Points of Attention During Operation

In order to ensure operation safety and operate with the optimal performance, please observe the following points of attention.

### Initial checking





For first-time operation, please check the tester to ensure there is no damage occurred during storage and shipment, no any abnormal function with the tester. Before operating, please make sure the insulation of testing clamps, the cables are flawless and no conducting part is exposed. Otherwise, using the meter will cause electrical damage and injury.

### Working environment

1. Ambient temperature and humidity:  $0 \sim 40 \text{ }^{\circ}\text{C}$  ( $32 \sim 104 \text{ }^{\circ}\text{F}$ ) < 80% RH (without condensation)
2. Range of temperature and humidity for guaranteed precision:
  - Earthing resistance measurements:  $0 \sim 28 \text{ }^{\circ}\text{C}$  ( $32 \sim 82 \text{ }^{\circ}\text{F}$ ) < 80% RH (without condensation)
  - Voltage measurements:  $23 \pm 5 \text{ }^{\circ}\text{C}$  ( $73 \pm 9 \text{ }^{\circ}\text{F}$ ) < 80% RH (without condensation)

### Operation

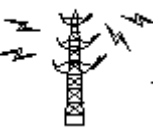
In order to avoid malfunctions and accidents, please do not subject the meter to the following situations:

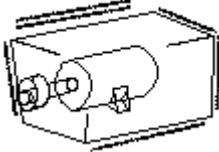
 <p>Direct Sunlight or High Temperatures</p>	 <p>Corrosive or Explosive Gas</p>	 <p>Water Spray or Condensation</p>
 <p>Strong Electromagnetic Environment</p>	 <p>Dust</p>	 <p>Mechanical Vibration</p>



Please observe the following instructions to avoid electrical shocking and short-circuiting.

- 1: Before connecting or disconnecting a tester clamp, please turn power off and make sure the clamp is detached from the object being measured .
- 2: Please do not perform any measurement when opening the battery lid.

- 3: Please do not take out the internal components out of the case.
- 4: Please do not use the tester under environment with inflammable or explosive gas or with a lot of dust. (otherwise explosion might occur)
- 5: Please do not put the tester at a place where it is unstable. (In case the meter falls off, it might cause electrical malfunctions and injuries. )



**Warning**

- 1: Voltage will be generated by this meter during measurements, therefore, please take insulation measures according to industrial safety regulations in order to avoid electrical shock and injuries.
- 2: Before usage, please remind relevant persons nearby to take protective measures.



**Note**

- 1: Operation range of temperatures for this meter is 0 to 40 °C (32 to 104 °F).
- 2: During handling, transportation and operation, mechanical vibrations, especially vibrations during accident of falling off, shall be prevented, so that meter damages are avoided.
- 3: In case the protecting function of the meter fails to work, please contact the supplier for service, or make distinct marking to prevent it being used by other persons.
- 4: Only professional service technicians are authorized to calibrate and repair the meter.
- 5: The meter shall not be altered in any way, and it can only be taken apart and repaired by the service engineers of our company. Otherwise, it might cause fire, electrical shock and physical injuries.
- 6: When the meter is not in use, please close the cover.
- 7: Please turn off power after use.

8: To avoid damaging the meter, please do not insert other devices into the USB socket.

9: If the rechargeable battery is exhausted, please recharge it immediately.

10: Do not replace the testing wire or clamp by your own, otherwise you shall be responsible for any problem it may cause.



### **Tips**

- 1: The standby status in this manual is referred to the situation under which no measurement is being performed and no parameter adjustment is going on.
- 2: In case ambient temperature changes abruptly in great number of degrees, it might cause condensation and incorrect measurements.
- 3: Before measuring, please place the meter under the new test environment for a period of time.

## General Description

### Product Introduction

This series advanced earthing-resistance testers integrated with multiple measuring methods, can be used for checking earthing-resistance of transformer, anti-lightning system, high-voltage power tower, and communication equipments, and its automatic frequency control (AFC) function can bring interference to an absolute minimum.

### Main functions

Basic function	Application
Earthing-resistance test	For testing the earthing-resistance of electrical equipments
Interference-voltage test	For testing the interference voltage of external circuits
Interference-current test	For testing the interference-current of external circuits
Soil resistivity test	For testing the average soil resistivity
AC resistance test	For testing resistance with 2-pole AC voltage
DC resistance test	For testing resistance with positive/reversed 2-pole DC voltage
Save	For saving test data
PC Communication	For transferring data to PC for analysis

### Features

Optional testing voltage	20 V/48 V
Optional testing frequency	94 Hz/105 Hz/111 Hz/128 Hz/AFC
Test mode	Multiple optional test modes
Data storage	100 test data can be stored, which can be checked on the meter or uploaded to PC software.
Display	Digital/analog dual display; LCD with backlight.

PC Communication	Uploading the stored data to PC software through USB interface for analysis.
Robust and Durable	With a compact structure, the tester is robust, durable and portable.
Powered by two batteries	Selecting LR14 alkaline battery or rechargeable battery bank through the switch.

### Names and Functions Of Components

Input terminals:

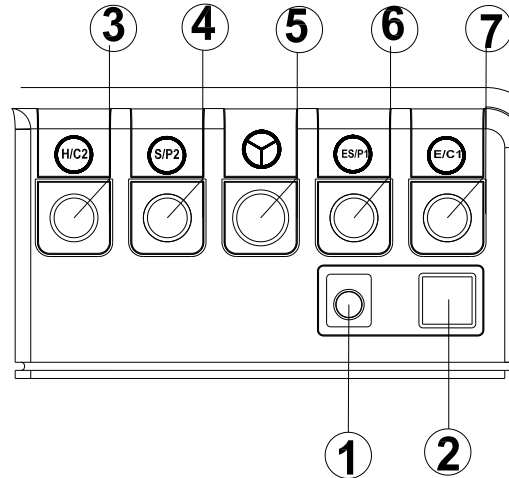

① <b>DC12V</b> Socket	For connecting a charger.
② <b>USB</b> Socket	For connecting USB cable with PC
③ <b>H/C2</b> Socket	For connecting red testing wire or H-terminal of voltage clamp

④ S/P2 Socket	For connecting yellow testing wire or S-terminal of voltage clamp
⑥ ES /P1Socket	For connecting the blue testing wire
⑦ E/C1 Socket	For connecting green testing wire or E-terminal of voltage clamp
⑤  Socket	For connecting current clamp

Back view:

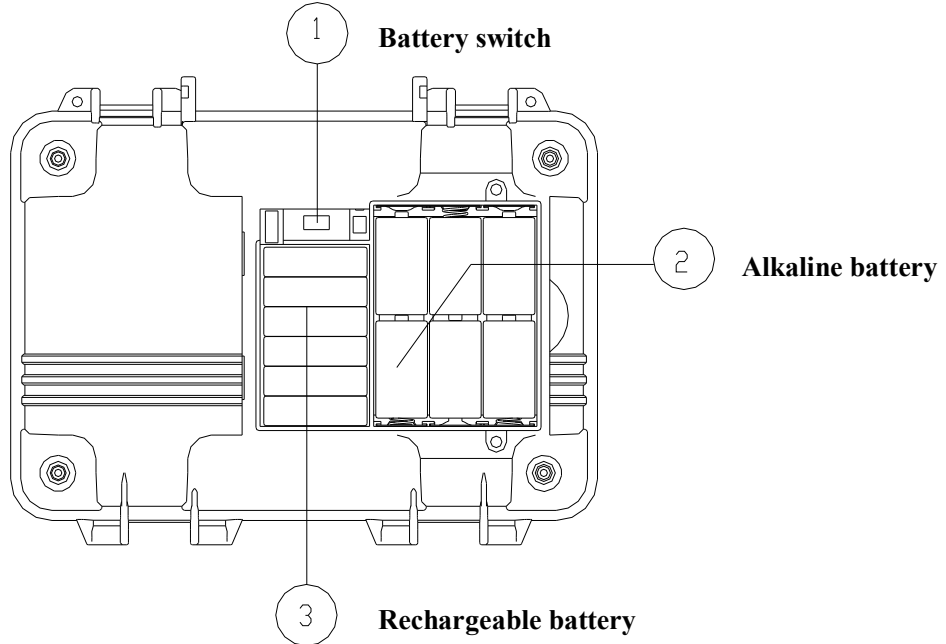



Operation panel:

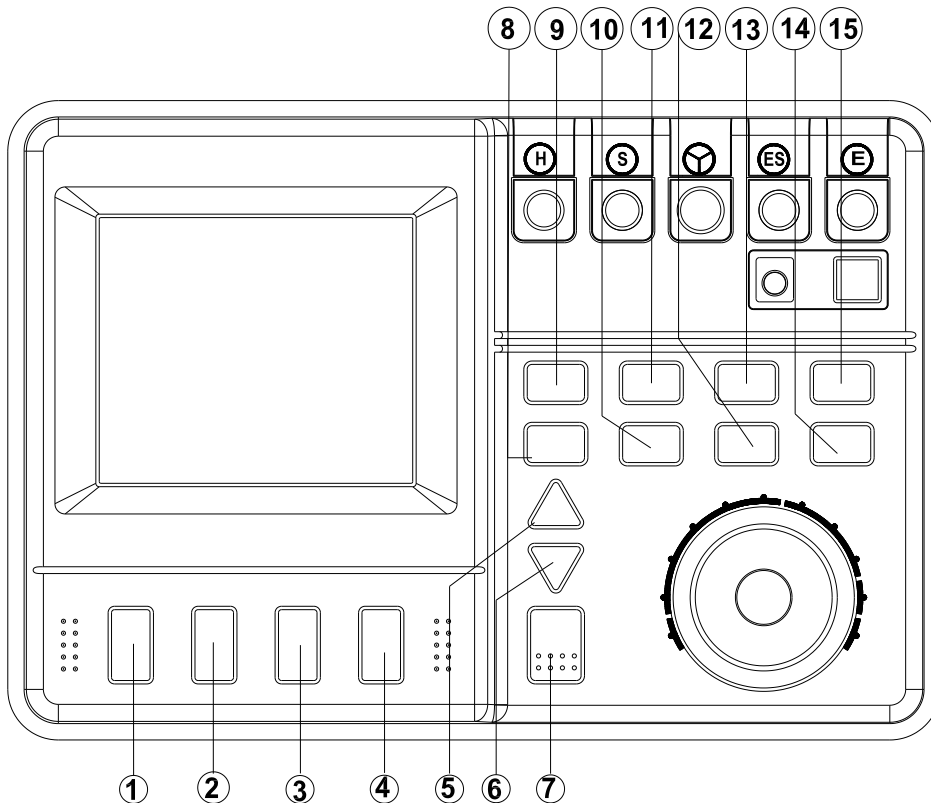





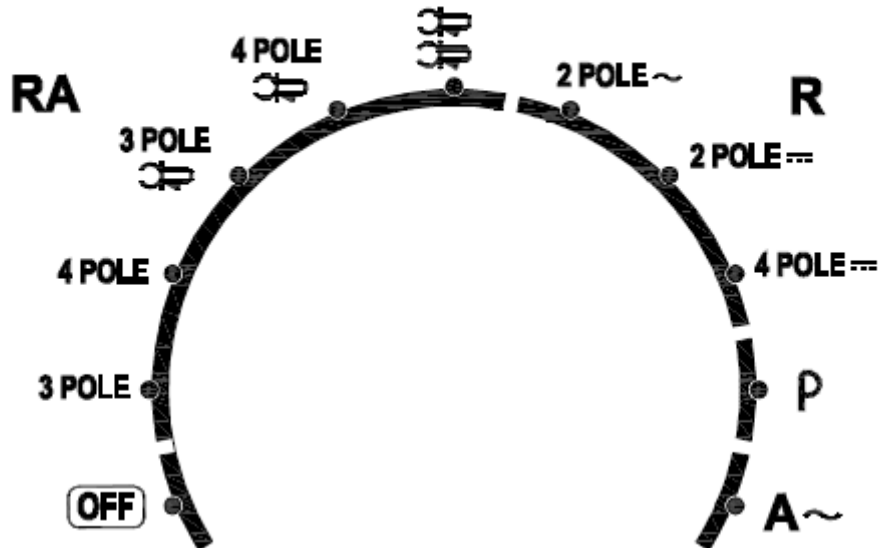

<b>Buttons</b>	<b>Functions</b>
① DISPLAY	To change displayed item; when testing resistance, press it to switch between resistance and current display; when data is hold, press it to switch among: Fst, Re, R~, R <del>---</del> , R1, R2, Rk, ρ, Fm, Ust, Um, Ist, and I~ .
② MEMO	To save measured data to internal non-volatile memory
③ READ	Read data from internal non-volatile memory
④ CLEAR	To clear data from internal non-volatile memory
⑤ △	To change the set value of testing voltage/frequency/date/time
⑥ ▽	To change the set value of testing voltage/frequency/date/time
⑦ MEASURE	To start or stop resistance test
⑧ RK	To start the resistance-compensation function of the test wire
⑨ V	To change testing voltage
⑩ B.LIGHT	To turn on/off LCD backlight which will be automatically turned off in 30 seconds; press the button during powering-on to cancel auto power-off function.
⑪ Hz	To change testing frequency
⑫ AVG	To start averaging function: measured resistance/current value can be processed in a smooth way

Buttons	Functions
⑬ LENGTH	To set distance between test points during resistivity measurement
⑭ ENTER	To confirm: the set value can be stored
⑮ CLOCK	1: To display date and time; 2: To switch input-cursor position when changing date/time

Rotary switch







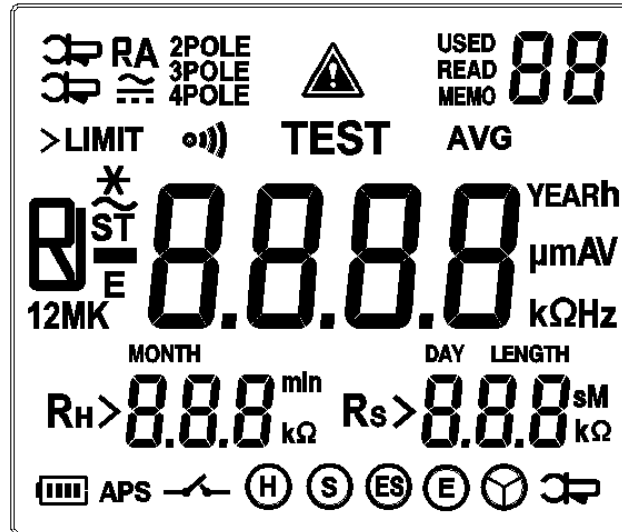



Rotary switch	Functions	Rotary switch	Functions
OFF	To turn off power	2 POLE R 	To test AC resistance with 2 POLE method
RA 3POLE	To test earthing-resistance with 3POLE method	2 POLE R 	To test DC resistance with 2 POLE method
RA 4POLE	To test earthing-resistance with 4POLE method	4 POLE R 	To test DC resistance with 4POLE method
RA 3POLE 	To test earthing-resistance with 3POLE method with current transformer	Soil resistivity <b>P</b>	To test soil resistivity with 4-pole method
RA 4POLE 	To test earthing-resistance with 4 POLE method with current transformer	Interfering current <b>A~</b>	To measure AC interfering current with current transformer
RA 	To measure earthing resistance with current transformer and voltage transformer		

## LCD



LCD symbol	Description
RE	Earthing resistance
RH	Auxiliary earthing resistance
RS	Probe resistance
Ust	Interfering voltage
Fst	Frequency of interference-voltage

LCD symbol	Description
Rk	Compensation resistance
Fm	Testing frequency
Um 20V/48V	Testing voltage
R1/R2	Resistor with direction
R~	AC resistance
APS	Auto powering off
AFC	Automatic frequency
TEST	A test is being performed
LIMIT	Limit value
>LIMIT	The limit value is exceeded
	Plug identification symbol
	Alarming indicator for limit-value exceeding
AVG	Indicator for averaged-value measurement
	Measurement is interfered or unstable
	Battery capacity indicator
READ	Reading data
MEMO	Storing data number
USED	There is data stored

LCD symbol	Description
LENGTH	Testing length between resistivity testing point
	DC symbol
	AC symbol
	Negative symbol
	Warning symbol

## Preparations Before the Test

### Power Check

Mode of power supply

1. LR14 alkaline battery
2. Rechargeable battery pack

Make your selection through DIP switch

### Battery Installation/Replacement

1. In order to avoid electrical damages, please turn off power and disconnect test wires from the meter before replacing batteries.
2. Please do not use an old battery in combination with a new one, and do not use batteries of different models.
3. Pay attention to battery polarity during installation so as to avoid meter damages or unnecessary injuries.
4. Please do not short-circuit or take apart used batteries in order to avoid explosion or environmental pollution.
5. Please properly dispose used batteries according to the requirements of local laws and regulations.
6. Replace the battery if there is an indication that the battery is short of power.

- 
7. Only designated batteries may be used.
  8. In order to avoid corrosion caused by battery leakage, please take out batteries when the meter is not to be used for a long period of time.

### **Steps for replacing alkaline battery**

1. Turn power off and disconnect all test wires.
2. Loosen screws on the back and take off battery cover.
3. Place 6 alkaline batteries in battery case.
4. Switch the battery selection switch to alkaline battery.
5. Put back battery-pack cover and tighten the screws.

### **Steps for replacing battery pack**

Using the optional rechargeable battery pack can extend the time period for continuous operation, and the battery can be recharged for many times. Before shipping, the rechargeable battery pack is not charged, therefore please fully charge it before use.

1. Turn off power, and take off all test clamps, AC charger, and USB cable.
2. Loosen screws on the back and take off battery cover.
3. Place the battery pack in the charging case.
4. Insert plug of the rechargeable battery pack into the charging socket.
5. Switch the battery switch to the position of “rechargeable battery”.
6. Put back battery cover and tighten screws.





1. Please use the designated rechargeable battery pack, and our company will not liable for any accidental injury or damage caused by using battery packs of other brands.
2. In order to avoid battery overheating which can induce explosion or leakage, please do not use the tester when connector of the tester is broken or when a battery or cable is damaged.
3. In order to avoid damaging electrical parts, please make sure that test clamps are taken off, power is turned off, and the charger is disconnected before installing or taking off the battery.
4. Please do not short-circuit or take apart used batteries in order to avoid explosion or environmental pollution.
5. Please properly dispose used batteries according to the requirements of local laws and regulations.

**Note**

1. Please do not subject the cable of battery pack to heavy pressure.
2. If the meter is not in use for a long period of time, please take off the battery pack and store it under  $-20\text{ }^{\circ}\text{C}$  to  $30\text{ }^{\circ}\text{C}$ .
3. Please charge the battery at least once every two months, because the battery performance will decrease if the battery is kept at a low level of power for a prolonged period of time. Please replace the battery if there is an indication that the battery is short of power.
4. Please charge the battery pack before use, because the power of the batter pack will decrease with time; Please replace the battery in case the time period for continuous operation decreases significantly with a fully charged battery.
5. Life of the battery is about 1 year, and the battery can be repeatedly charged for around 500 times.

**Connecting a charger**

With the charger connected, the tester can be used to charge rechargeable batteries, communicate with a PC, and change the settings. However, measurements of earthing resistance, interference current, and voltage cannot be carried out under this situation.

1. Install rechargeable battery pack.

---

insert the AC power plug of the charger into the AC power socket.

2. Fast charging is started. During fast charging, the power status indicator will flash; if the charger is connected to the tester which is turned off, the tester will be automatically turned on power and start fast charging.
3. At the end of fast-charging, the power indication symbol will stop flashing, and trickle charging will begin (to keep the battery being fully charged).



### Warning

1. Please stop measuring before connecting the charger to the tester and AC power; please use charger of the designated brand; the range of input voltage of charger is: 100 – 240 VAC  $\pm$  10%, 50/60 Hz. In order to avoid damaging the electrical parts of the tester, please do not use voltage that exceeds the above range.
2. In order to avoid electrical malfunctions and ensure operation safety, please make sure that the power socket connected with power cable is well earthed.
3. When using the testing clamps for measurement, please do not connect the charger to the tester.



### Note

1. After the charger is connected to AC power and the tester, the tester will automatically select the charger for supplying power.
2. If the charger is connected and rechargeable batteries are installed, the tester will automatically turn on power and charge the batteries, as well as managing the charging process.
3. The charging time is about 3 hours under an ambient temperature of 23 °C.
4. The temperature range for battery charging is 10 – 40 °C, and temperature will affect the charging efficiency; If

the battery is charged under a temperature out of the above range, the battery power will decrease and the battery performance will be compromised.

5. Batteries cannot be charged with the test clamps connected.
6. The position of the battery selection switch will not affect battery charging.
7. During charging, the tester can still communicate with PC, however, it cannot be used to measure earthing resistance or interference current/voltage.
8. Please use designed battery charger.
9. If the battery is fully charged and the tester is not in use, please disconnect the plug of the charger from the tester in order to prevent prolonged trickle-charging from compromising battery performance.

### **Auto powering off**

1. Rotate the “Rotary switch” from OFF position to other test position, and data will be shown on screen after 1 second and the tester will enter Sleep mode; upon powering-on, the parameters which were set before powering-off last time will be automatically loaded.
2. If there is no operation within 2 minutes, the tester will be automatically turned off; before it is turned off, APS symbol will flash for 10 seconds. During charging, auto powering-off function will be invalid. Press and hold “B.LIGHT” button during powering-on to cancel the auto powering-off function.
3. After tester is automatically power off, you can press any button to activate it from sleep mode.
4. If the battery power is at a low level, please replace battery or charge it in time; if you continue using the meter after ‘LobAt’ is displayed, the meter will be automatically turned off.
5. Rotate “Rotary switch” to OFF position, the screen display will be turned off and power is off.

## Setting and Checking Date / Time

### Setting date and time

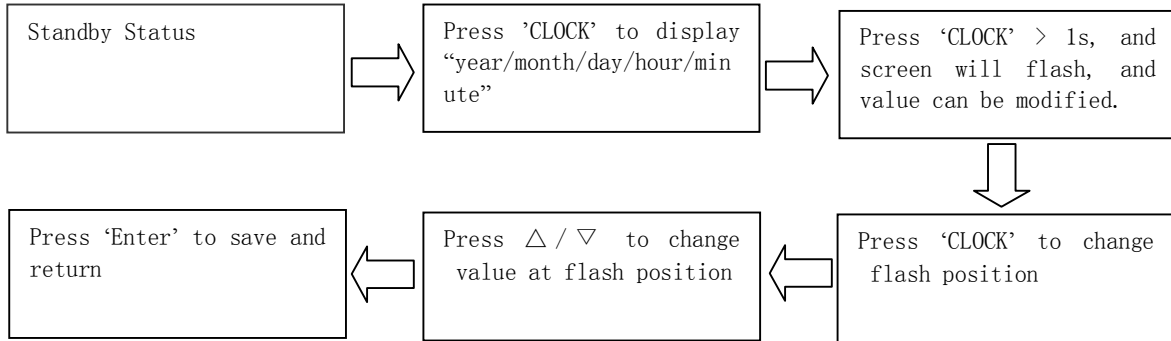

Note 1: Upon pressing the Enter button, the clock starts to run from 0 seconds.

Note 2: Date and time can be adjusted through the communication software which is installed on a PC.

### Checking date and time

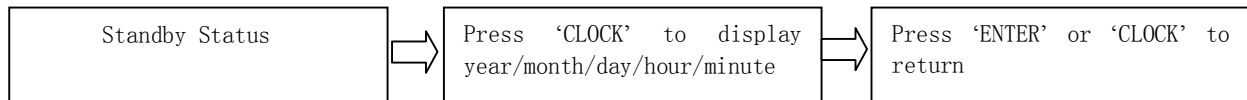

## Connecting Testing Wires

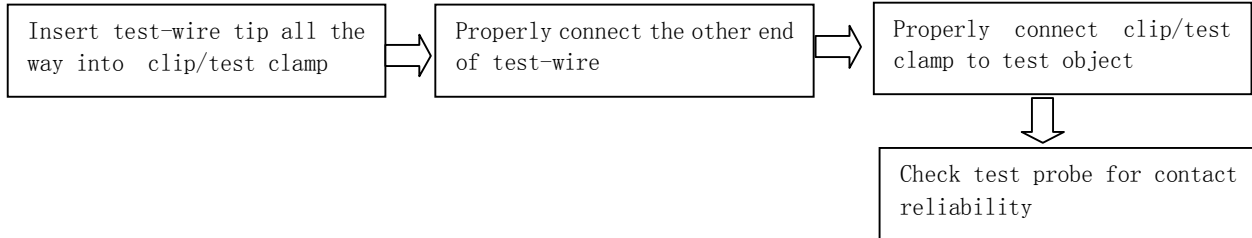

**Danger**

1. Before connecting/disconnecting a test clamp, please make sure that the clamp is detached from the object being measured and power is turned off in order to avoid electrical damages.
2. In order to avoid electrical damages, please do not use the tester when the housing is damaged.
3. This instrument can only be used in systems without voltage.

---

## Test Method

Introduction of methods for measuring earthing resistance

With 3-pole/4-pole earthing-resistance testing function, the earthing resistance of single-point earthing system and soil resistivity can be measured; with 3 pole/4 pole method and current clamp, resistance of a single branch circuit in an inter-connecting network can be tested without disconnecting the earthing system; with current clamp and voltage clamp, resistance in an inter-connecting network can be tested without disconnecting the earthing system.

### Checking before the Test



#### Warning

1. Check the bottom shell of the tester, top cover, testing wires, alligator clips, clamp head, and socket for damages; please do not use the meter in case any damage is found.
2. Please make sure that the socket is clean and dry. Use a piece of dry cloth to wipe off any water to avoid test error.
3. Before measurement, please make sure that the test object is not live.
4. Dangerous voltages might be generated at the test terminals during earthing-resistance measurements, and therefore please do not touch the terminals/test probes/object being tested in order to avoid electric shock.
5. In order to avoid damaging the equipment that is to be tested, please check the test voltage before measurement.

### Measuring with 3-pole/4-pole method

Start testing

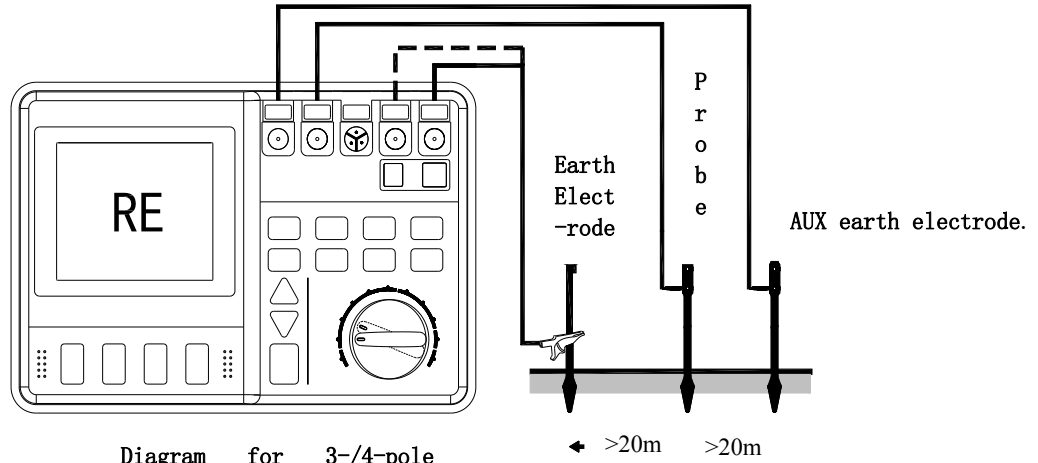
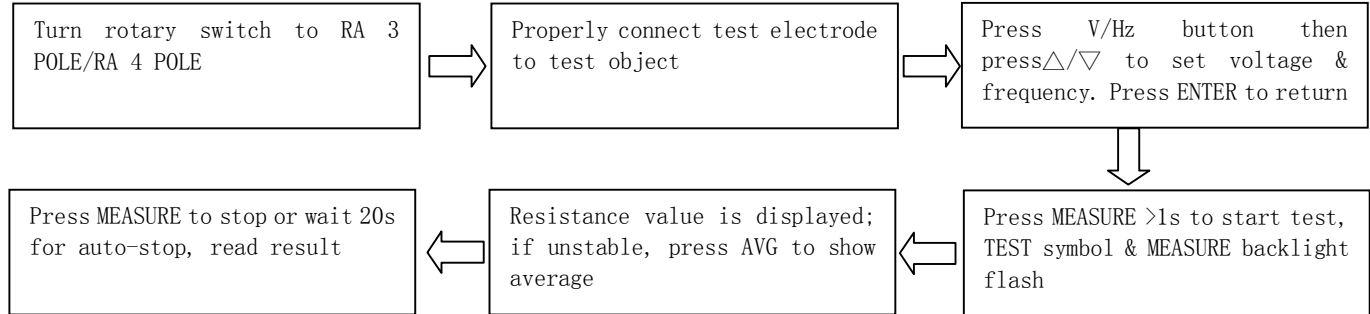







Diagram for 3-/4-pole



### Tips

1. If       is flashing, it indicates problematic test-wire connection; please check and correct connections.
2. If '>' and LIMIT symbol start to flash, it indicates the measured value is too large and exceeds the measuring range.
3. If readings are not stable, you can use the measurement average function as follows: press AVG button to activate/deactivate AVERAGE function; after AVG symbol is displayed, the readings will be updated every 4 seconds; however, the readings will still be updated every 1 second under the following situations: within the first 15 seconds after the start of measurement; within the first 5-10 seconds after the measuring range is changed.









### Note

1. Do not let the test clamps come into contact with each other, and do not place other objects on the clamps so that measuring errors can be avoided.
2. Before use, please make sure the test clamps are clean; a smeared clamp will adversely affect the measurement. Earthing resistance is not stable. For certain objects, test values from repeated measurement might not be consistent.
3. The capacitance and resistance of the object being tested might be low initially, and then increase gradually, and finally be stabilized.
4. Keep test wire at an appropriate distance from each other.
5. A distance above 20 m should be kept among probe, auxiliary earthing-electrode, and earthing pin, and the three should be aligned; generally the above settings can meet normal requirements.

Earthing-resistance measurement cannot be started under the following circumstances:

- 1) When  $U_{st}$  voltage is greater than 24 V (for earthing resistance RE or AC resistance R ~ measurement) or 3 V (for DC resistance R  measurement).



- 2) When       symbol or its corresponding indicator LED is flashing.
- 3) When battery voltage is too low and LObAt symbol is displayed.
- 4) When an error message is displayed.

Finishing a test

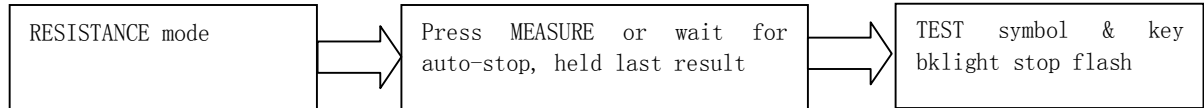

### Note

- 1: Before stopping measuring, do not disconnect the test clamp from the object being tested.
- 2: When voltage drops below 3 V, backlight for TEST, flashing symbols and MEASURE button will be turned off.
- 3: In case battery power is insufficient during measurement, the tester will automatically stop the measurement and LObAt symbol will be displayed.

### Review and delete the held data

After earthing resistance measurement is finished, the following values will be displayed on screen.

- |                                  |     |
|----------------------------------|-----|
| 1. Earthing resistance           | RE  |
| 2. Auxiliary earthing resistance | RH  |
| 3. Probe resistance              | RS  |
| 4. Interfering voltage           | Ust |
| 5. Interfering frequency         | Fst |
| 6. Compensation resistance       | Rk  |

## 7. Testing frequency

Fm

'DISPLAY' button for switching display (3 pole method)

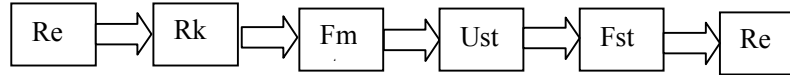

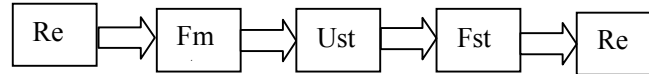

'DISPLAY' button for switching display (4 pole method)

**Note**

The held data will be cleared after powering off, therefore please use SAVE function to save data.



**Delete the held data**

Push and hold CLEAR button longer than 1 second to clear the held data.

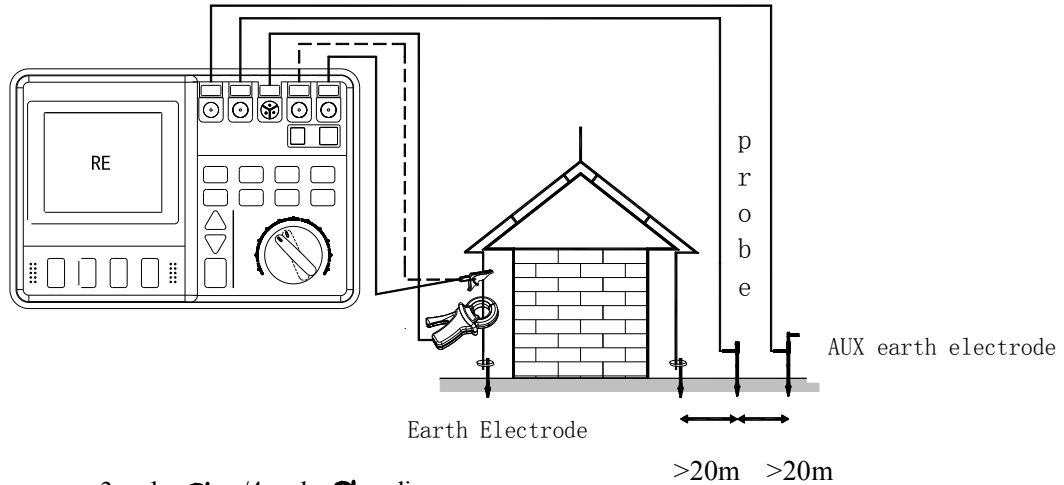
Selecting measuring method (3 pole+  /4 pole+  method)



Start testing

3-pole  /4-pole  diagram

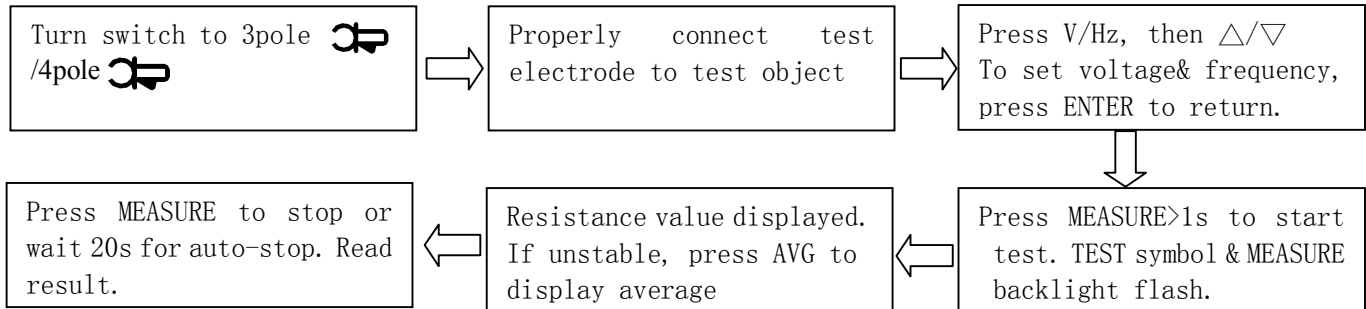

## Finishing a test

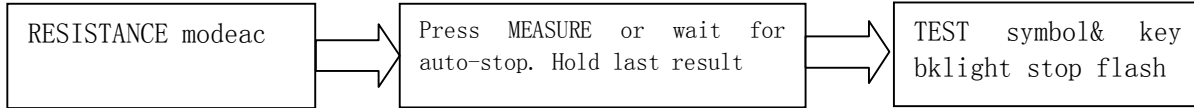

### Note

1. Before stopping measuring, do not disconnect the test clamp from the object being tested.
2. When voltage drops below 3 V, backlight for TEST, flashing symbols and MEASURE button will be turned off.
3. In case battery power is insufficient during measurement, the tester will automatically stop the measurement and LObAt symbol will be displayed.

## Review and delete the held data

After earthing resistance measurement is finished, the following values will be displayed on screen:

- |                                  |     |
|----------------------------------|-----|
| 1. Earthing resistance           | Re  |
| 2. Auxiliary earthing resistance | Rh  |
| 3. Probe resistance              | Rs  |
| 4. Interfering voltage           | Ust |
| 5. Interfering frequency         | Fst |
| 6. Compensation resistance       | Rk  |
| 7. Testing frequency             | Fm  |

‘DISPLAY’ button for switching display 3 pole  method

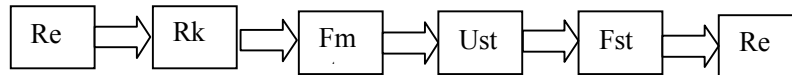

'DISPLAY' button for switching display 4-pole  method

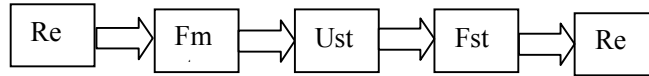

### Note

The held data will be cleared after powering off, therefore please use the MEMO function to save data.

### Delete the held data

Push CLEAR button and hold it longer than 1 second to clear the held data.

### Test of Earthing-Resistance without Stake

When testing single earthing-resistor in an parallel earthing-connecting system, if the parallel earthing resistance of  $R_1 \dots R_n$  is much lower than the earthing resistor  $R_x$  that is being tested, then  $R_x \approx U/I$ .

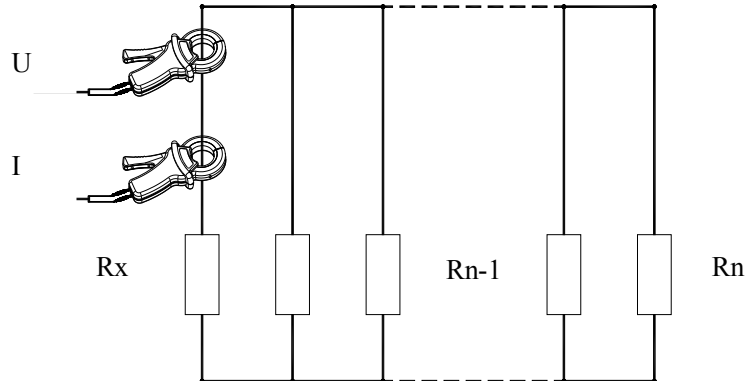

Stakeless testing

Start testing

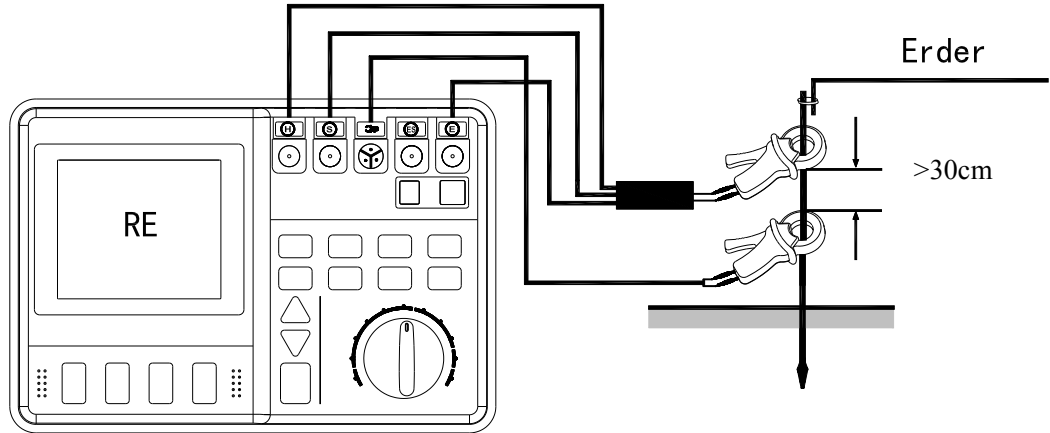
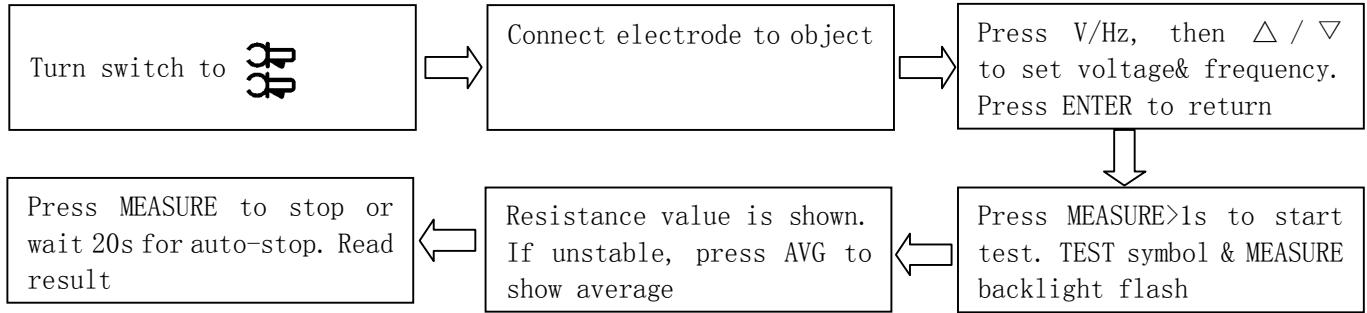

Stakeless-test diagram

**Note:** During the test without stake, the distance between two clamp heads should be larger than 30 cm.

Review/delete the held data

'DISPLAY' button for switching display (  )

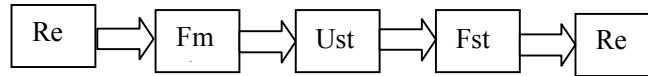

### Delete the held data

Push CLEAR button and hold it for longer than 1 second to clear the held data.

### AC Resistance Test

Measuring resistance with AC method; when testing resistance is lower, it can be considered to use Rk to compensate the test wire.

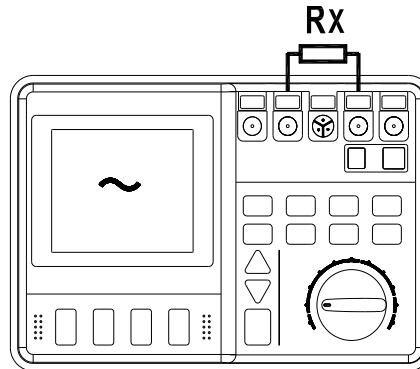

AC-resistance connections

Start testing

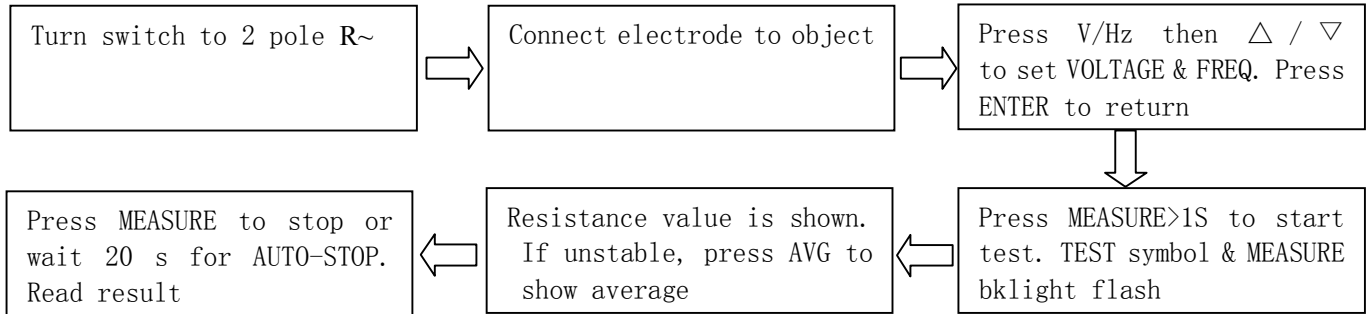

‘DISPLAY’ button for switching display (2 pole R~)

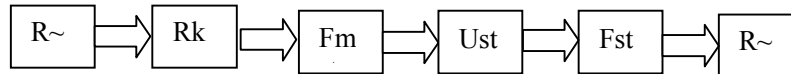

**DC Resistance Test**

Test resistance with DC voltage and polarity reversing method as per EN61557-5: to attain the highest accuracy, you can test with DC 4 pole method; if necessary, you can use Rk function to compensate the test wire.



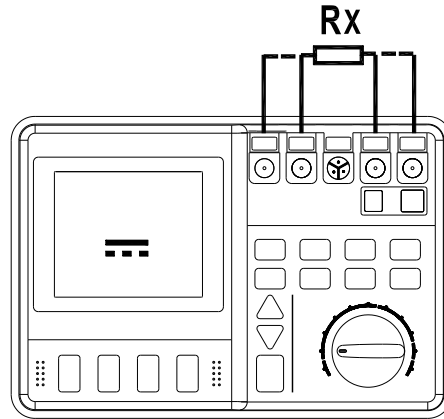

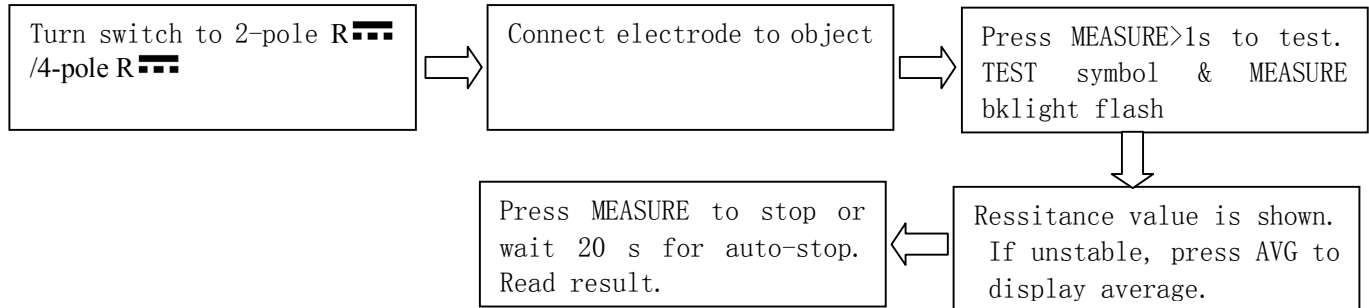

2-pole R  /4-pole R   
Connections

Start testing

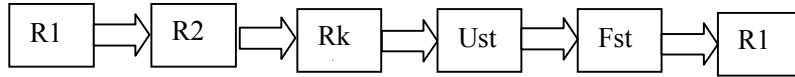

‘DISPLAY’ button for switching display (2 pole R )



‘DISPLAY’ button for switching display (4 pole R )



### Soil Resistivity Test

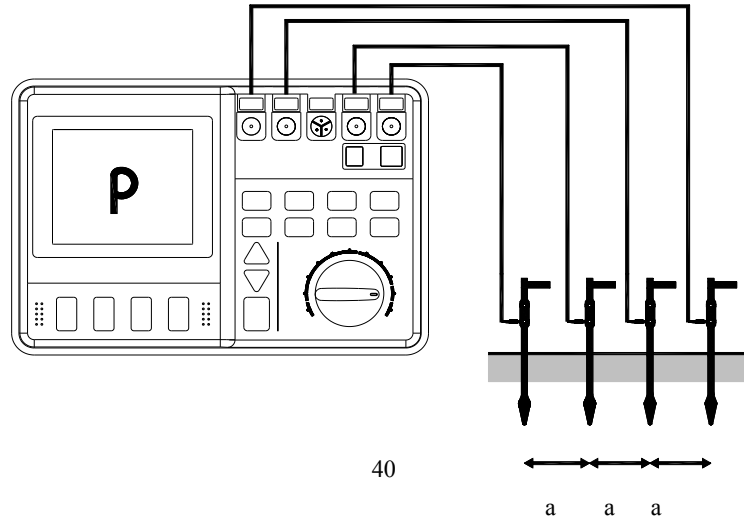

## Start testing

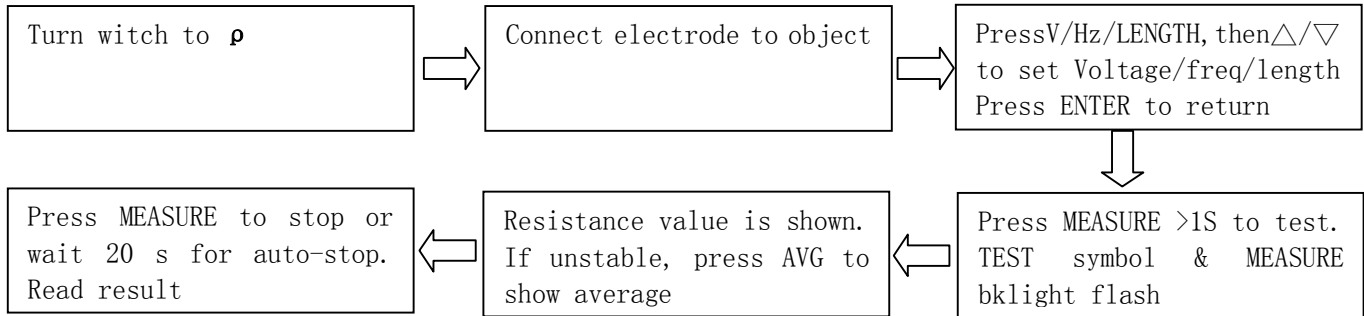

‘DISPLAY’ button for switching display (soil resistivity  $\rho$ )



Resistance  $R_e$  can be calculated from the displayed resistivity  $\rho$

$$R_e = \rho / 2\pi \cdot a$$

P: the average soil resistivity  $\Omega \cdot m$

$R_e$ : the test resistance  $\Omega$

a: probe distance (2 m -30 m)

Deeper layer of soil can be measured by increasing “a”, and its uniformity can be tested. If “a” is changed for multiple times, a plot can be obtained, by which a proper earthing electrode can be determined; depending on the test depth, “a” is usually between 2 and 30 m. With this method, a plot as described in the following chart can be obtained.

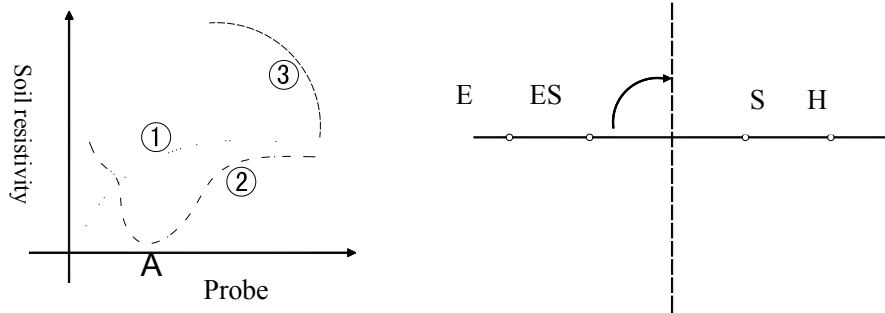



Plot 1: When depth is increased and  $\rho$  is not decreased: a bar-shaped conductor electrode is recommended.

Plot 2: When  $\rho$  is only decreased toward A point, increasing depth, which is larger than A, will not improve the measured value.

Plot 3: When  $\rho$  is only decreased downward, a deep-buried earthing electrode is recommended.

**Note:** underground metals and soil layer containing water will result in unreliable test results; hence a second test is suggested with earthing pin being rotated by 90° around its axis.

### Test-wire resistance (Rk) measurement

When Rk function is used with 3 pole method /3 pole  2 pole R~ /2pole R  , error due to test-wire resistance can be eliminated with Rk compensation.

Measurement calculation: Re displayed value = Measured value – Rk

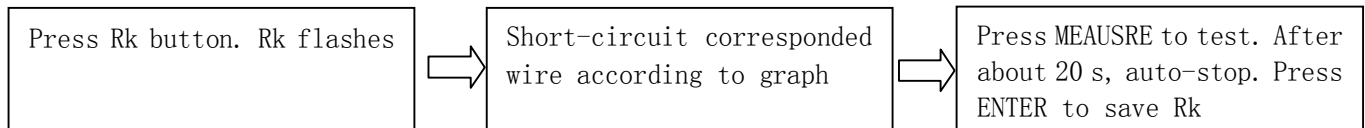

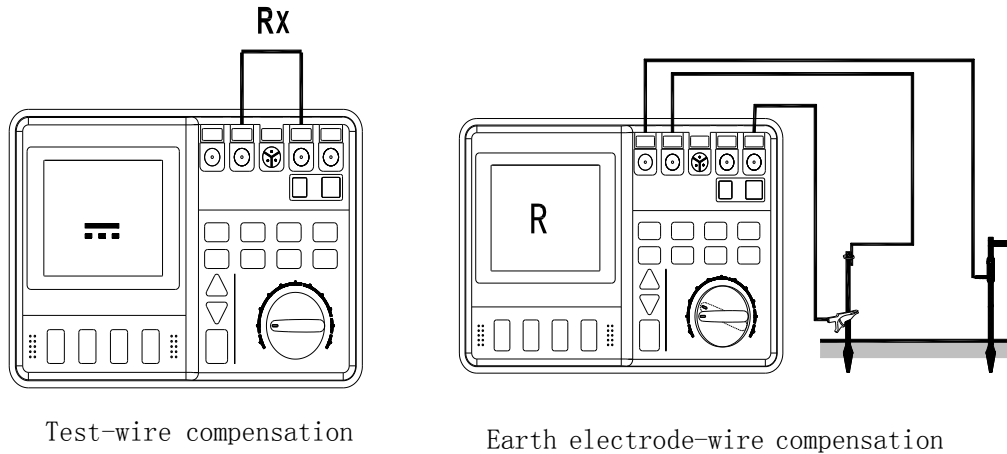

Test-wire compensation

Earth electrode-wire compensation

**Note:** If the tester is restarted after powering-off, the pre-set  $R_k$  value is not saved.

### Interference voltage/frequency test

Before testing earthing resistance, the tester automatically start this function with priority; only when interference voltage is greater than 1 V, the meter can display the measured interference voltage/frequency; if interference voltage is greater than 24 V during AC resistance test or 3 V during DC resistance test, earthing resistance test will be automatically prohibited. You can review the test value of interference frequency with DISPLAY button.

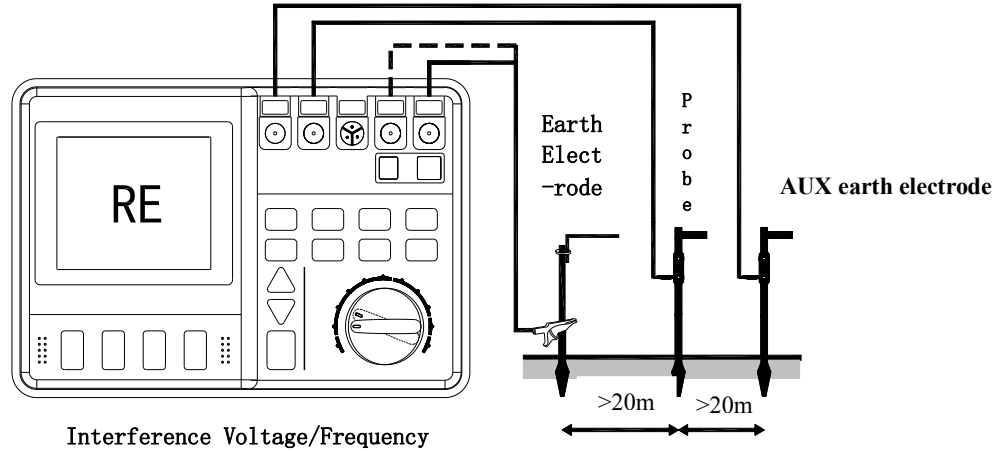

### Interference-Current Test

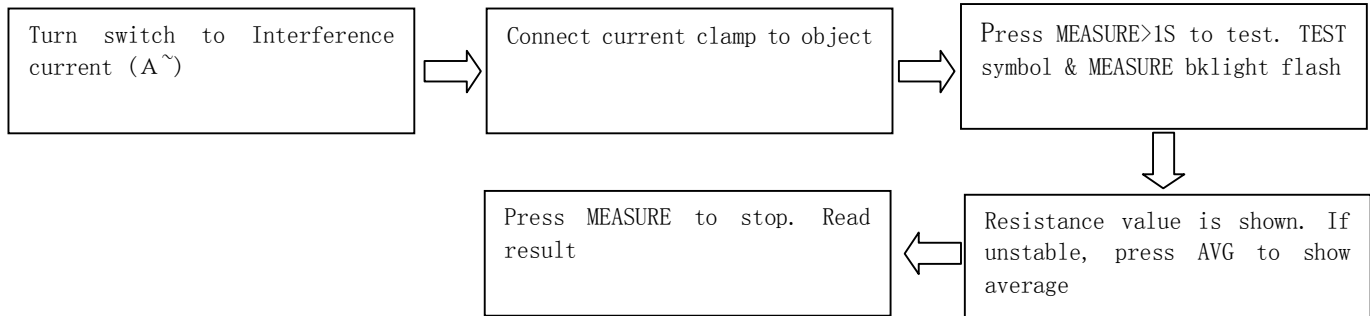

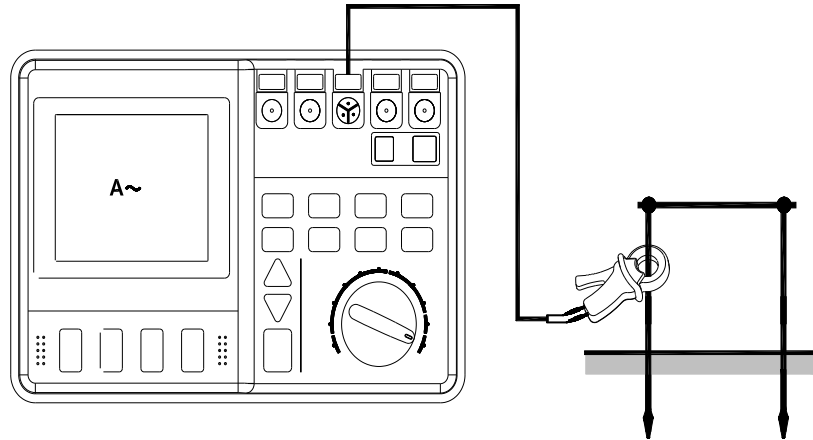

Interference current

‘DISPLAY’ button for switching display (interference current A ~)

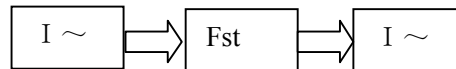

## For Saving Test Data

1. The tester can save test data, set parameters, time and date in the internal memory, and the saved data will not be lost after powering-off.
2. The saved data can be reviewed on the tester, and uploaded to PC via USB port.

## Data Storage

Altogether 100 data can be saved with the number as: 00 – 99.

## Operation procedures

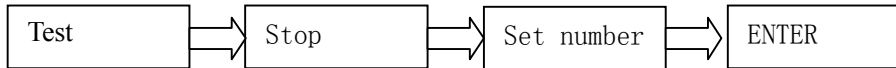

## Operation steps

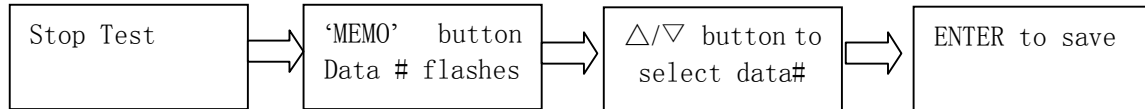

## Tips

1. If USED symbol is displayed for the selected data number, the saved data will not be overwritten.
2. If MEMO button is pushed instead of ENTER button, data will not be saved and the system will directly return to the previous interface.



3. Compensated resistance value  $R_k$  cannot be saved.
4. Interference voltage/current/frequency cannot be saved.

## Reviewing Saved Data

Operating steps:

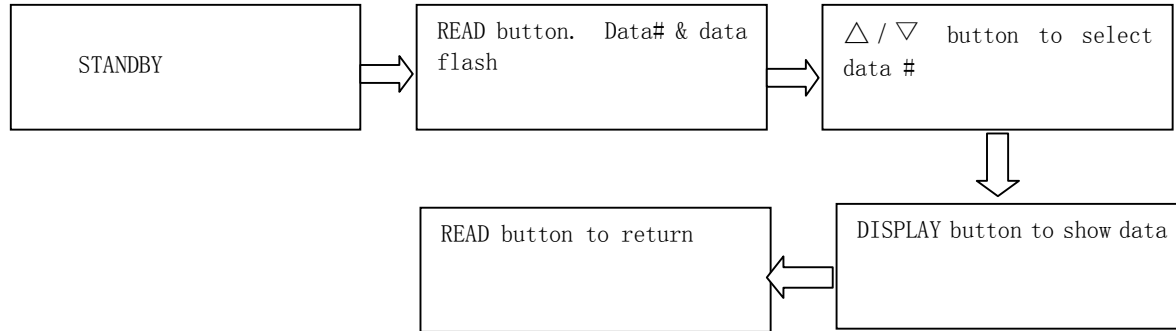

### Tips

**Note 1:** Push READ button under STANDBY mode (MEMO No. symbol must be turned off)

**Note 2:** Push READ button, and ‘no dAt’ will be displayed at the upper right corner if there is no data in the memory, and ‘no dAt’ will automatically disappear after 1 second.

Part of the recorded data is not directly displayed on screen; to review data that is not displayed, you need to push DISPLAY button for switching.

‘DISPLAY’ button for switching display (RA 3pole method and RA 3pole  method)



DISPLAY button for switching display (RA 4-pole method and RA 4pole  method)

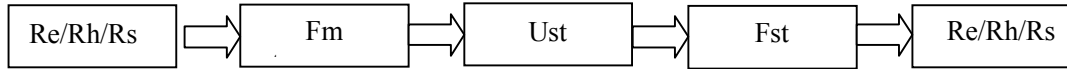

DISPLAY button for switching display (RA  )



DISPLAY button for switching display (2 pole R~ method)

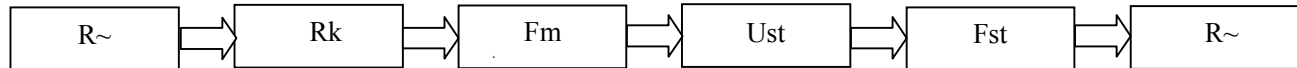

DISPLAY button for switching display (2-pole R  method)

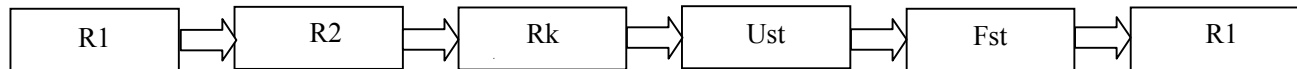

DISPLAY button for switching display (4-pole R  method)

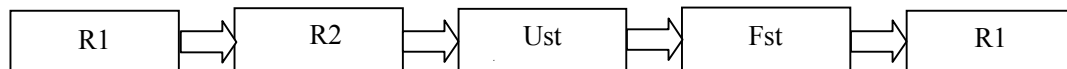

DISPLAY button for switching display (soil resistivity  $\rho$ )



DISPLAY button for switching display (interference current A~)



### Deleting Saved Data

#### Delete specified data

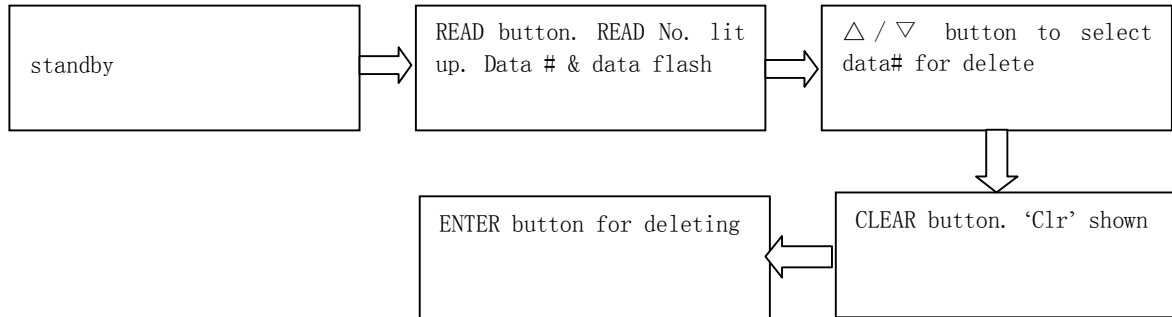

**Note:** If 'READ' button is pushed instead of 'ENTER' button, data will not be deleted and the system will directly return to the previous interface.

#### Deleting all data

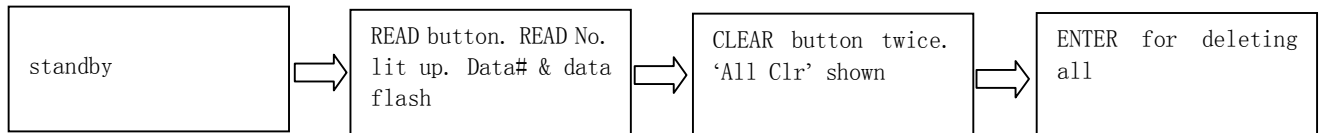

**Note:** If READ button is pushed instead of ENTER button, data will not be deleted and the system will directly return to the previous interface.

## **PC Communication**

### **Operation System Requirement:**

1. Operation system: Windows 2000, Windows XP
2. Hard-disk capacity: 100 MB available space
3. Interface: USB 2.0

### **Functions of PC Software**

1. To obtain saved data from the tester
2. Display obtained data and saving test data
3. Set tester parameters

### **Installing PC Software:**

1. Double click on SETUP.EXE in the supplied software disk.
2. Install software according to software instructions.

### **Downloading Data to PC/Configuring the Tester**

When the test clamps are connected to the tester, please do not connect the tester with PC.

1. Use USB cable to connect the tester with PC.
2. Run the communication software on PC.

**Note:** During data transfer between PC and tester, do not unplug the USB cable so that transfer errors can be avoided.

## Specifications

### General Specifications

Table 1:

Ambient temperature and humidity for test	0~40°C, < 80% RH (without condensation)
Temperature for battery charging	10~40 °C , < 80% RH
Storage temperature and humidity	-10~50 °C , < 90% RH (without condensation)
Temperature & humidity for battery-pack storage	-20~30°C, < 80% RH (without condensation)
Altitude for storage	< 12000 m
Altitude for operation	< 2000 m
Clamp Diameter	φ 51mm
Display	LCD with backlight; Max. number: 9999
Overflow indication	> LIMIT
Underflow indication	-
Frequency for updating display	For earthing-resistance/leak-current: once per second (once in every four seconds if AVERAGE function is used )
	Detection of output voltage: twice per second
	Interference voltage: 4 time per second
	Interference frequency: once per second

	Interference current: once per second
--	---------------------------------------

Table 2:

Terminals	1) Resistance test:  2) USB, charger
Power supply	1) LR14 alkaline battery × 6; rated voltage: 1.5 V × 6 2) Battery pack: rechargeable nickel - metal hydride batteries; rated voltage: 7.2 V 3) Charger: rated input voltage: 100 ~ 240 V; rated frequency: 50 ~ 60 Hz; output voltage: 12 VDC 3A
Max. power consumption	15 VA (using charger) 6 VA (using batteries or rechargeable battery pack)
Max. powering time	Alkaline battery: about 5 hours; battery pack: about 9 hours (with backlight turned off)
Max. input voltage	250 V AC (50~400 Hz)
Max. rated voltage to earth	300 Vrms (CAT III)
Insulation strength	6880 VAC: 15 seconds
Overload protection	250 VAC between terminals: 1 minute
Dimensions	About 260 (W)×125 (H)×280 (L) mm
Weight	About 2.5 kg
Applicable standards	1. Safety: EN61010-1:2001, EN61010-031:2002, Pollution degree 2; Measurement category III 300V; 2. EMC: EMC: EN61000-3-2:2000 IEC61326-1: 1997 A grade

Table 3: Main functions:

Testing earthing resistance, soil resistivity, interference voltage/interference/current
Compensating test-wire resistance
Data saving function: recording (100 records), deleting a single record, deleting all records, uploading data to PC
Clock
AVERAGE function for test data
ALARM function for input terminals
Charging battery
Auto powering-off

## Technical Specification

### RA 3pole method

Testing voltage	AC 20/48V
Testing frequency	94Hz/105Hz/111Hz/128Hz/AFC(Meter A/Meter B)
	94 Hz/128 Hz(Meter C)
Short-circuit current	250mA(Meter A)
	100mA(Meter B, Meter C)
Test duration	26s
Probe resistance $R_s$	< 100 k $\Omega$

Auxiliary earthing resistance Rh	< 100 kΩ
Re resolution	0.001 Ω
Re Measuring range	0.02Ω~300kΩ ±(5%rdg+10d) (Meter A)
	0.1Ω~30kΩ ±(5%rdg+10d) (Meter B)
	0.1Ω~20kΩ ±(5%rdg+10d) (Meter C)
Ust	< 24V
Fst	16 ~ 400 Hz

**Note 1:** Range of temperature and humidity in which measuring precision is guaranteed: 0 - 28 °C, < 80% RH (without condensation)

**Note 2:** Response time < 15 seconds (Time needed for attaining the specified precision for the displayed value from the start of measurement with average function turned off).

#### RA 4 pole method

Testing voltage	AC 20/48V
Testing frequency	94Hz/105Hz/111Hz/128Hz/AFC(Meter A / Meter B )
	94 Hz/128 Hz(Meter C)
Short-circuit current	250mA(Meter A)
	100mA(Meter B, Meter C)
Test duration	30s
Probe resistance Rs	< 100 kΩ
Auxiliary earthing resistance Rh	< 100 kΩ
Re resolution	0.001 Ω



RE Measuring range	0.02Ω~300kΩ    ±(5%rdg+10d) (Meter A)
	0.1Ω~30kΩ    ±(5%rdg+10d) (Meter B)
	0.1Ω~20kΩ    ±(5%rdg+10d) (Meter C)
Ust	< 24V
Fst	16 ~ 400 Hz

**Note 1:** Range of temperature and humidity in which measuring precision is guaranteed: 0 - 28 °C, < 80% RH (without condensation)

**Note 2:** response time < 25 seconds (Time needed for attaining the specified precision for the displayed value from the start of measurement with AVERAGE function turned off).

RA 3pole  method (Meter A/Meter B)

Testing voltage	AC 20/48V
Testing frequency	94Hz/105Hz/111Hz/128Hz/AFC
Short-circuit current	250mA(Meter A)
	100mA(Meter B)
Test duration	26s
Probe resistance Rs	< 100 kΩ
Auxiliary earthing resistance Rh	< 100 kΩ
Re resolution	0.001 Ω
Re Measuring range	0.02Ω~20kΩ    ±(5%rdg+10d) (Meter A)
	0.1Ω~10kΩ    ±(5%rdg+10d) (Meter B)
Ust	< 24V

Fst	16 ~ 400 Hz
-----	-------------

Note 1: Range of temperature and humidity in which measuring precision is guaranteed: 0 ~ 28 °C, < 80% RH (without condensation)

Note 2: Response time < 25 seconds (Time needed for attaining the specified precision for the displayed value from the start of measurement with average function turned off).

Note 3: If current on current clamp is too low, measuring might be terminated.

RA 4pole  method (Meter A/Meter B)

Testing voltage	AC 20/48V	
Testing frequency	94Hz,105Hz,111Hz,128Hz /AFC	
Short-circuit current	250mA(Meter A)	
	100mA(Meter B)	
Test duration	26s	
Probe resistance Rs	< 100 kΩ	
Auxiliary earthing resistance Rh	< 100 kΩ	
Re resolution	0.001 Ω	
RE Measuring range	0.02Ω~20kΩ	±(5%rdg+10d) (Meter A)
	0.1Ω~10kΩ	±(5%rdg+10d) (Meter B)
Ust	< 24V	
Fst	16 ~ 400 Hz	

**Note 1:** Range of temperature and humidity in which measuring precision is guaranteed: 0 - 28 °C, < 80% RH (without condensation)

**Note 2:** Response time < 25 seconds (Time needed for attaining the specified precision for the displayed value from the start

of measurement with average function turned off).

**Note 3:** If current on current clamp is too low, measuring might be terminated.

Test of earthing-resistance without stake  (Meter A/Meter B)

Testing voltage	AC 48V
Testing frequency	94Hz/105Hz/111Hz/128Hz/AFC
Short-circuit current	250mA(Meter A)
	100mA(Meter B)
Test duration	26s
Re resolution	0.001 Ω
RE Measuring range	0.02~150Ω ±(10%rdg+10d)
	0.1~150Ω ±(10%rdg+10d)
Ust	< 24V
Fst	16 ~ 400 Hz

**Note 1:** Range of temperature and humidity in which measuring precision is guaranteed: 0 ~ 28 °C, < 80% RH (without condensation)

**Note 2:** Response time < 25 seconds (Time needed for attaining the specified precision for the displayed value from the start of measurement with average function turned off).

**Note 3:** If current on current clamp is too low, measuring might be terminated.

Soil resistivity test ρ

Testing voltage	AC 20/48V
Testing frequency	94Hz/105Hz/111Hz/128Hz/AFC(Meter A/Meter B)
	94 Hz/128 Hz(Meter B)



Short-circuit current	250mA(Meter A)
	100mA(Meter B/Meter C)
Test duration	26s
$\rho$ resolution	0.001 $\Omega \cdot m$
$\rho$ Measuring range	0.02 $\Omega \cdot m \sim 1000 k\Omega \cdot m \quad \pm(5\%rdg+10d)$

## 2pole R~



Testing voltage	A C 20V
Testing frequency	94Hz/105Hz/111Hz/128Hz/AFC(Meter A/Meter B)
	94 Hz/128 Hz(Meter C)
Short-circuit current	250mA(Meter A)
	100mA(Meter B / Meter C)
Test duration	26s
R~ resolution	0.001 $\Omega$
R~ Measuring range	0.02 $\Omega \sim 300k\Omega \quad \pm(5\%rdg+10d) \quad$ (Meter A)
	0.1 $\Omega \sim 30k\Omega \quad \pm(5\%rdg+10d) \quad$ (Meter B)
	0.1 $\Omega \sim 20k\Omega \quad \pm(5\%rdg+10d) \quad$ (Meter C)
Ust	< 24V
Fst	16 ~ 400 Hz

2pole R  (Meter A/Meter B)

Testing voltage	DC 20V
-----------------	--------

Short-circuit current	250 mA (Meter A)
	100 mA (Meter B)
Test duration	26s
R  resolution	0.001 Ω
R  Measuring range	0.02Ω~3kΩ ±(5%rdg+10d) (Meter A)
	0.1Ω~3kΩ ±(5%rdg+10d) (Meter B)
Ust	≤ 3V
Fst	16 ~ 400 Hz

4pole R  (Meter A/Meter B)

Testing voltage	DC 20V
Short-circuit current	250mA(Meter A)
	100mA(Meter B)
Test duration	26s
R  resolution	0.001 Ω
R  Measuring range	0.02Ω~3kΩ ±(5%rdg+10d) (Meter A)
	0.1Ω~3kΩ ±(5%rdg+10d) (Meter B)
Ust	≤ 3V
Fst	16 ~ 400 Hz

## Compensation for Rk test-wire resistance (2-pole method)

Testing voltage	AC 20/48V
Testing frequency	94Hz/105Hz/111Hz/128Hz/AFC(Meter A / Meter B)

	94 Hz/128 Hz (Meter C)
Short-circuit current	250mA(Meter A)
	100mA(Meter B / Meter C)
Test duration	26s
R resolution	0.001 $\Omega$
R Measuring range	0.02~30.00 $\Omega$ $\pm(3\%rdg+10d)$ (Meter A)
	0.1~30.00 $\Omega$ $\pm(3\%rdg+10d)$ (Meter B / Meter C)
Ust	< 24V
Fst	16 ~ 400 Hz

#### Interfering voltage/current/frequency

Test method	Measuring range	Resolution	Precision
Interference-voltage test	$\pm 1VDC \sim \pm 50VDC$ /1VAC~50VAC	0.1V	$\pm (5\% rdg+5dgt)$
Interference-current test	20mA~2A	1mA	$\pm(5\%rdg+5dgt)$ (Meter A / Meter B)
Interference-frequency test	16 ~ 400 Hz	1Hz	$\pm(1\%rdg+10dgt)$

## Maintenance and Repair

1. If it seems that there is a problem with the tester, please make sure that batteries have enough power and the connection of test clamps is in good condition.
2. Before mailing out the tester for service, please take off batteries and properly pack the tester to prevent damages during transportation, and describe the problem in detail; our company is not liable for any damage caused by

transportation.

- The rechargeable battery can be charged about 500 times and used for about 1 year; please replace the rechargeable battery in case the time period for continuous operation decreases significantly with fully charged batteries.

### Table of trouble shooting

In case the tester does not function well, please first conduct checks according to the following table.

Problems	Items for check	Measures to be taken
Tester cannot be powered on.	Are batteries installed? Is battery power very low?	Install new batteries
	Does polarity match for the battery?	Check polarity
	Are batteries charged?	Charge the rechargeable battery
	Is the battery selection switch correctly selected?	Check the position of the battery selection switch
Batteries cannot be charged.	Is the charger correctly attached?	Check if the charger is correctly attached
	Are rechargeable batteries installed?	Install rechargeable batteries.
Earthing resistance value is incorrect.	Is there a problem with test clamps?	Replace the test clamp
	Is test clamps properly inserted?	Properly insert test clamp
	Are test clamps connected to correct terminals?	Check the terminals
The detected voltage is very low during earthing-resistance test.	Is the resistance value very small?	The output voltage should be very low when the resistance is low
Communication with PC failed.	Is USB cable correctly installed?	Correctly install the USB cable

<b>Problems</b>	<b>Items for check</b>	<b>Measures to be taken</b>
Powering off during measurement.	Is battery power insufficient?	Replace the battery
	Are rechargeable batteries fully charged?	Charge the battery

### **Cleaning**

Dip soft cloth in clean water or non-aggressive cleaner, and then wipe and clean the tester. Please do not use benzene type of solvent, alcohol, acetone, ether, ketone, thinner, gasoline, etc., which will cause deformation or decoloration; finally, use dry cloth to wipe it clean.

### **Disposal**

Used testers should be disposed of and the rechargeable battery should be removed in compliance with local laws and regulations.

**Note:** After replacing new batteries, date and time, etc. should be set again.



## Appendix table: Soil resistivity

Soil type	Soil resistivity	Earthing resistance $\Omega$					
		Earthing rod depth (m)			Earthing bar (m)		
	$\Omega\text{m}$	3	6	10	5	10	20
Rotten/swamp/wet soil	30	10	5	3	12	6	3
Plantation/sticky soil	100	33	17	10	40	20	10
Sandy soil	150	50	25	15	60	30	15
Wet sandy soil	300	66	33	20	80	40	20
Dry sandy soil	1000	330	165	100	400	200	100
Concrete 1: 5*	400				160	80	40
Wet sand layer	500	160	80	48	200	100	50
Dry sand layer	1000	330	165	100	400	200	100
Stone soil	30000	1000	500	300	1200	600	300
Rock	10000000	-	-	-	-	-	-

If concrete ratio is 1:7, increase the value in the above table by 24%.

